

MFJ *cub*

QRP CW Transceiver

Models: MFJ-9315/17/20/30/40/80



OPERATION MANUAL

CAUTION: Read All Instructions Before Operating Equipment

MFJ ENTERPRISES, INC.

300 Industrial Park Road
Starkville, MS 39759 USA
Tel: 662-323-5869 Fax: 662-323-6551

INTRODUCTION

Congratulations on purchasing the MFJ *cub* Transceiver. The *cub* takes advantage of SMD technology to achieve big-radio performance in a pocket-sized package. Whether you're taking a 10-minute DX break from the computer, or backpacking in the mountains, the *cub* is a great way to put the magic back into ham radio. Here are a few of the features we think you'll appreciate:

Hot Receiver: Pulls in *weak* QRP signals.

Low Noise: Virtually no noise contribution from receiver electronics.

Sharp Passband: Ladder filter and shaped audio reject unwanted QRM and QRN.

Differential-Mode AGC: Audio output holds steady over 80-dB signal range.

Robust AF Output: 100 mW AF amp drives headphones and speakers with ease.

Adjustable Transmitter: Power output continuously variable for QRP.

Full QSK: Seamless electronic switching for smooth break-in.

Natural Sidetone: Receiver monitors actual on-air signal.

Shaped Keying: Controlled envelope for click-free keying.

Custom Set-up: Transmit offset and receiver passband both user adjustable.

Low Power Drain: Runs from any lightweight regulated power source.

Truly Portable: Set up anywhere and tuck out of the way when not in use.

Simple to Use: Off/on switch, volume control, and tuning knob--that's it!

Attractive: Rugged aluminum case looks good, and it's built to last.

Ergonomic Layout: Controls conveniently positioned.

TYPICAL SPECIFICATIONS

Cub models are available for six popular QRP bands. Typical performance for each is shown in the following table:

Model	VFO MHz	Tuning kHz	IF Freq MHz	-6dB Selectivity	MDS Selectivity	USB dB	Power W*	Spurs dBc
9315	9	50	12	750	<.3uV	-38	1.0	-40
9317	8.06	50	10	600	<.3uV	-45	1.5	-40
9320	4	60	10	600	<.3uV	-45	2.0	-40
9330	4.1	20	6	350	<.3uV	-56	2.0	-40
9340	5	60	12	750	<.3uV	-38	2.2	-40
9380	6	60	10	600				

*RF power output at 13.8 Vdc supply voltage.

CONTROL LOCATIONS AND FUNCTIONS

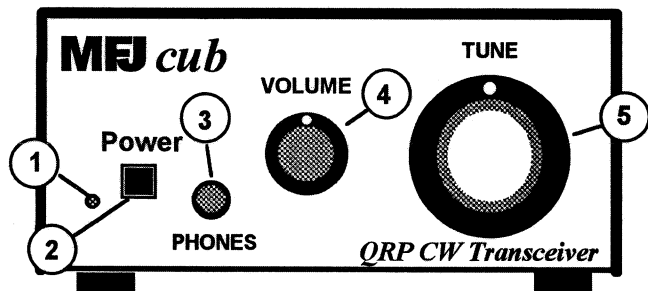

- 1. Power LED:** Indicates when transceiver is turned on.
- 2. Power Switch:** Applies power to transceiver.
- 3. Phone Jack:** Accepts 3.5 mm stereo headphone jack (stereo wiring).
- 4. Volume Control:** Adjusts volume to comfortable level.
- 5. VFO Tuning:** Selects transceiver's operating frequency.

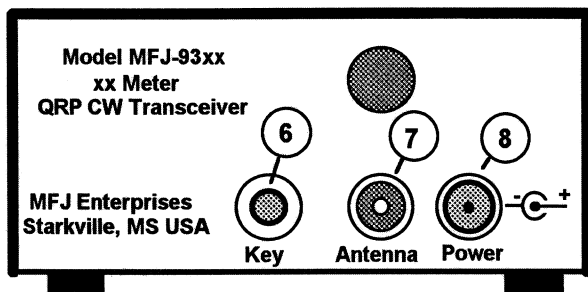

- 6. **Key Jack:** Accepts 3.5 mm plug from key or keyer, mono wiring.
- 7. **Antenna Jack:** Accepts RCA plug from 50 ohm antenna.
- 8. **Power Jack:** Accepts 5.5 mm OD, 2.1 mm ID coaxial plug, (+) to center.

QUICK-START OPERATING INSTRUCTIONS

Power Sources: The *cub* requires a regulated 12-14 VDC source capable of delivering 400 mA. Power connection requires a 5.5 mm x 2.1 mm coaxial plug (use Radio Shack 274-1567). Wire (+) voltage to center terminal, and (-) to common.

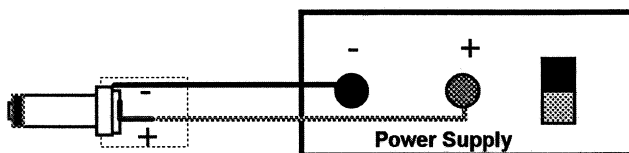

Important Note: Unregulated DC sources--wall cubes, solar panels, etc.--may damage your radio. A simple regulator circuit, like the one shown below, will provide protection. Note that U1's heat sink is 1.8 V above ground and must be isolated.

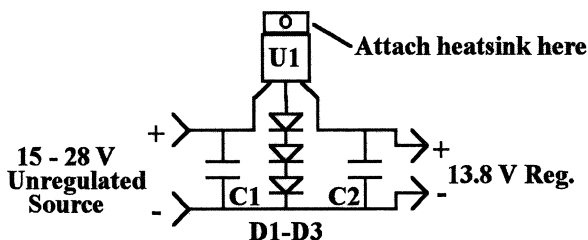

- Parts**
- U1 - 7812 Regulator
 - D1-D3 - 1N4001 Diode
 - C1-C2 - .1 uF

Headphones: Use standard walkman-type stereo headphones exhibiting 8-40 ohms impedance (higher-quality headsets often yield better performance). Alternatively, plug in any extension speaker with a similar load impedance. *Be sure to use only stereo type plugs--a mono plug will short the radio's audio output to ground!*

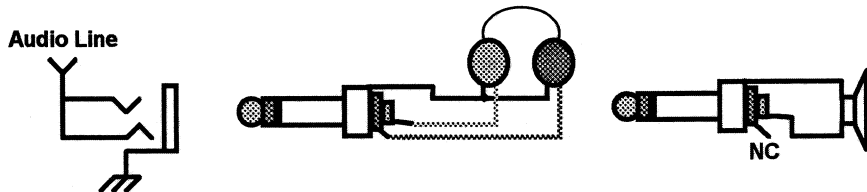

Keys and Keyers: Use any hand key or electronic keyer with a 3.5 mm plug (mono or stereo plug okay). Connect the key line to the jack's tip and the common line to the sleeve.

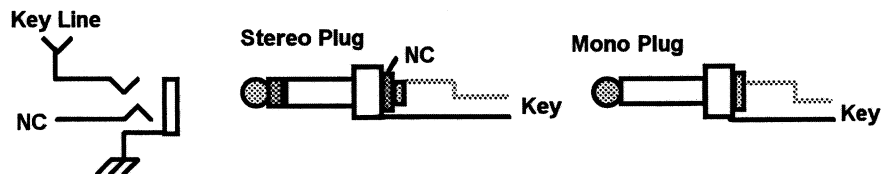

Antennas: The *cub* is designed to work with any efficient 50 ohm antenna exhibiting a VSWR of 2:1 or less. Suggested dipole lengths are shown in the following diagram, along with data for adding a simple coaxial choke-type balun:

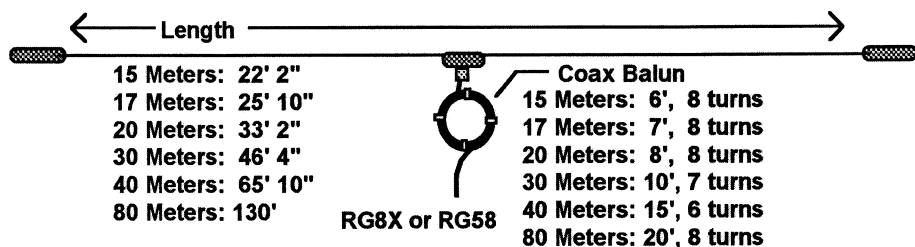

For best performance with any antenna, install as high and in the clear as possible. *The ARRL Antenna Handbook, The ARRL Antenna Compendium, and many other amateur publications--including several from MFJ--offer additional antenna tips and suggestions.*

Antenna Connection: The *cub* uses either a RCA antenna jack or the optional chassis-mounted BNC connector (mounting hole provided). For a direct transition from RCA to standard UHF (PL-238) connectors, use a Radio Shack scanner-adaptor plug RS278-208. Shorten the center pin--as shown--for easier insertion and removal.

RS 278-208
UHF to
Motorola
Adapter

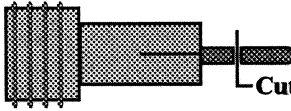

Cut here and smooth off tip with a file.

BNC-to-UHF transitions are also readily available if the optional BNC jack is installed.

Adjusting Power Output: The small hole in the center of the *cub's* cover provides access to a power-level trimpot (R19). For low power (QRP), adjust this trimpot counter-clockwise (CCW) with a small screwdriver while observing output on a QRP-type power meter. To increase power, turn the trimpot clockwise (CW). When resetting the *cub* for full power, note that output will increase rapidly then reach a plateau where it levels off. *Adjust R19 only to the point where the power increase begins to level off.* Attempting to wring the last few milliwatts from your radio by turning the trimpot fully clockwise will only overdrive the transmitter mixer stage and add unwanted spurious products to your signal.

GETTING INVOLVED WITH QRP

Technically speaking, operating QRP means limiting your transmitter power to below 5 watts on CW or below 10 watts PEP on sideband. However, for a growing number of licensed amateurs, the "QRP" moniker symbolizes a return to the basics of radio--with a strong emphasis on operating skills, experimentation, home construction, and fraternity. Spanning a continent or hopping oceans with less energy than it takes to illuminate a night light is not only exciting, it borders on the miraculous. Yet, QRP enthusiasts do it every day--often using simple home-built equipment running only microwatts of power. Even staunch QRO contesters have succumbed to the lure and challenge of QRP, revisiting DXCC while running 5 Watts or less. For many, operating "QRP" restores that special sense of personal achievement that's too easily lost when high-tech appliances invade the ham shack. Regardless of motivation, this particular segment of the ham radio community is growing steadily and continues to thrive as other techno-fads come and go.

QRP Calling Frequency: To meet up with other low-power enthusiasts, try operating on the QRP International Calling Frequencies. These are popular gathering places for people who share your interest in QRP activities:

80 Meters:	3.560 MHz	(3710 Novice)
40 Meters:	7.040 MHz	(7.110 Novice)
30 Meters:	10.106 MHz	
20 Meters:	14.060 MHz	
15 Meters:	21.060 MHz	

QRP-A.C.R.I.: To learn more about QRP activities, your best resource is *QRP Amateur Radio Club International* (or QRP-A.R.C.I.), a worldwide organization supporting low-power operation and home construction. This popular group sponsors several contests a year, publishes *QRP Quarterly Magazine*, and coordinates an annual QRP conference in tandem with Dayton Hamvention. You can find QRP-A.R.C.I. on the World Wide Web at www.qrparci.org. They also provide links to local and regional QRP clubs around the world, plus links leading to a wealth of operating and technical information.

QRP DX Operating Tips: Competing with more powerful stations to capture QSLs from rare DX prefixes requires patience and good operating skills. Here are 10 tricks-of-the-QRP-trade you can use with your *cub* to land the tough ones!

1. Hunt and pounce! There's never a pileup if you're the first one there.
2. Seek out and answer CQs (as opposed to repeatedly calling CQ).
3. Add */QRP* to the end of your call. Let others know you're running low power.
4. Answer CQs from weak stations as well as strong--they may be QRP too.
5. Be patient in pileups. You'll get the same QSL whether you're first or last in line!
6. Use QSB and band swings to advantage. When they get stronger, you might too!
7. Look before you leap. Wait for a lull to sneak in your call.
8. Move up or down from the pileup. Being on the edge helps your signal stand out.
9. Call DX stations as they wrap up QSOs (but not over the other station's final).

10. Pay attention to DX forecasts. When the band is hot, power differences matter less.

CIRCUIT DESCRIPTION

In receive, Chebechev filter L1-L2 preselects incoming signals. U2 converts signals to the IF using its internal LO as a varactor-tuned VFO. IF amp Q1 drives ladder filter Y1-Y3. Product detector U3 recovers the AF product, using its internal LO as a crystal-controlled BFO. Audio is then routed to AF amplifier U4 through differential attenuator Q3. U4, which is EQ'd for CW, selectively amplifies signals to speaker-level. Level detector D3 samples U4 output and returns a AGC signal to attenuator Q3. Volume is controlled by a resistive attenuator downstream of the level detector. The receiver remains on in transmit mode to provide CW sidetone.

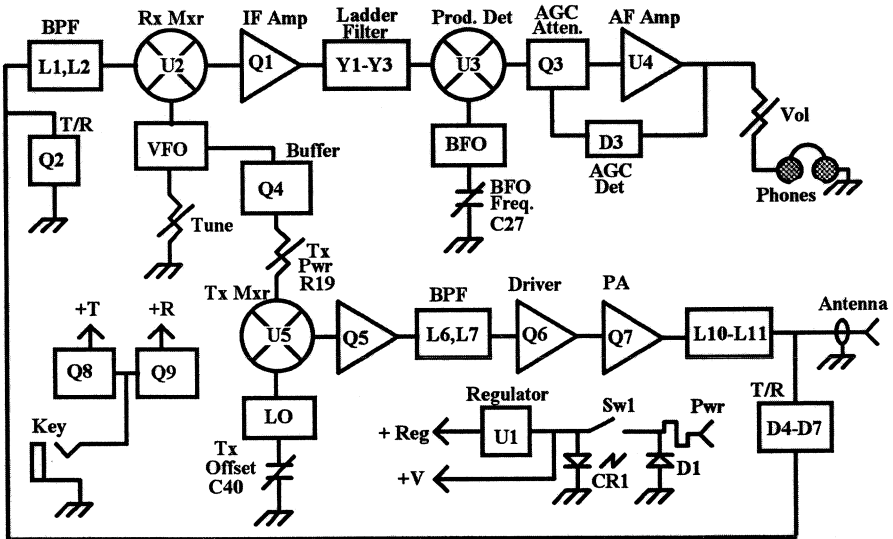

In transmit, buffer Q4 samples U2's VFO signal and feeds it through attenuator R19 to transmit mixer U5. Q5 boosts U5 output, and Chebechev filter L6-L7 selects the desired mixer product. Driver Q6 boost the filtered signal and feeds it through an L network to class-C PA amplifier Q7. +T switch Q8 is keyed to generate CW characters. This powers U5, Q5, and the bias line to Q6. Pi-filter L10-L11 reduces transmitter harmonic content.

On key-down, antenna switch D4-D7 is biased open by Q8. Also, Q2 is biased into conduction by Q9--pulling the receiver input to ground. These two gates

produce -75 dB port isolation, allowing the receiver to monitor the transmitted signal without overload. Crowbar diode D1 protects circuitry from reverse-polarity power connection, and LED CR1 indicates when the radio is on. Construction is hybrid, employing a mix of SMD and conventional "through-hole" components to reduce size and increase reliability.

IN CASE OF DIFFICULTY

If you experience a problem with your *cub*, look through the checklist below to determine if it's something simple you can fix yourself. If that fails to resolve the problem, you may contact *MFJ Technical Service* at 662-323-0549 or the *MFJ Factory* at 662-323-5869. You will be best helped if you have your unit, manual and all information on your station handy so you can answer any questions the technicians may ask.

You can also send questions by mail to MFJ Enterprises, Inc., 300 Industrial Park Road, Starkville, MS 39759; by Facsimile to 662-323-6551; or by email to techinfo@mfjenterprises.com. Send a complete description of your problem, an explanation of exactly how you are using your unit, and a complete description of your station.

Won't Power Up: Check power source and associated cables/plugs. Check reverse-polarity fuse (pc trace behind power jack). If blown, replace with loop of #32 wire.

No Signals Heard: Check antenna and feedline for breaks and shorts. Is the band dead? Try a different antenna.

Unwanted Signals: Intermod from strong BCI may be overloading the frontend. If using a large multiband antenna, try a smaller monobander. Also, check station ground.

Intermittent Audio: Check headphones or extension speaker and cord/plug.

No Transmit: Check key or keyer and its cord/plug. Is the keyer battery okay?

Sidetone, But No RF Out: Is R19 turned down? Check patch cord to power meter.

MFJ CUB ALIGNMENT AND SERVICE NOTES

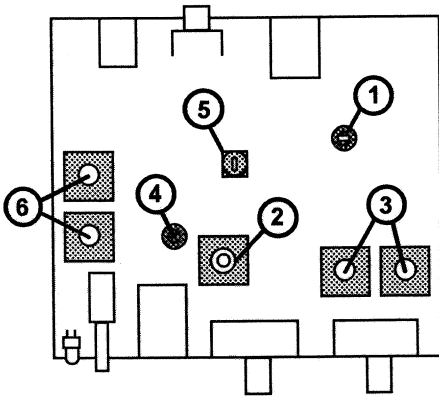

Alignment Control Function

- 1. BFO Trim (set for 600-Hz LSB passband center)
- 2. VFO Cal (set for desired CW band segment)
- 3. Rx BPF (tune for maximum sensitivity)
- 4. Tx Offset (set for 600-Hz sidetone pitch)
- 5. Power (set for onset of gain compression)
- 6. Tx BPF (tune for maximum power output)

Important Note: If you lack the necessary test equipment and skills to make these adjustments, seek assistance from a qualified technician. Misalignment will degrade transceiver performance and may also result in spurious out-of-band operation in violation of FCC rules. MFJ *cannot* be held responsible for transceiver misalignment in the field.

Voltage Chart: Voltage charts are useful for diagnosing circuit problems and isolating component failures. Any voltage variation of 10% or more *may* indicate a problem.

Important Note: Exercise caution when testing SMD circuitry with conventional bench probes. If the voltmeter probe shorts to adjacent pins during the measurement, component damage may result. If you lack the tools and training to troubleshoot SMD circuitry, seek assistance.

Transistor Voltages

	Q1	Q2	Q3	Q4	Q5*	Q6*	Q7	Q8	Q9
E/D	0	---	---	13.8	---	---	---	13.8	12.8
B/S	0.7	---	---	2.7	0.7	0.3	---	13.3	13.5
C/G	8.3	13.8	---	---	8.3	13.8	13.8	0.4	13.8

*Voltage values obtained with radio in transmit mode. Do not place test probe on Q7 during transmit--RF may damage meter.

IC Voltages

Pin	U1	U2	U3	U4	U5*
1	7.9	1.4	1.4	1.3	1.4
2	0	1.4	1.4	---	1.4
3	0	0	0	---	0
4	---	4.2	4.3	0	4.7
5	---	4.2	4.3	7.2	4.7
6	0	5.4	5.5	13.8	5.8
7	0	4.9	5.1	7.0	5.5
8	13.8	5.5	5.5	1.4	5.9

Component Pinout:

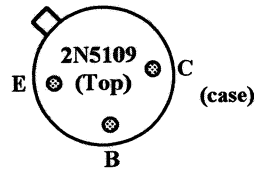
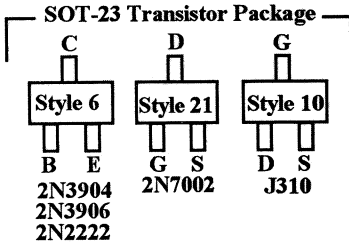
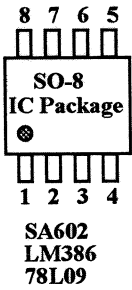

PARTS PLACEMENT

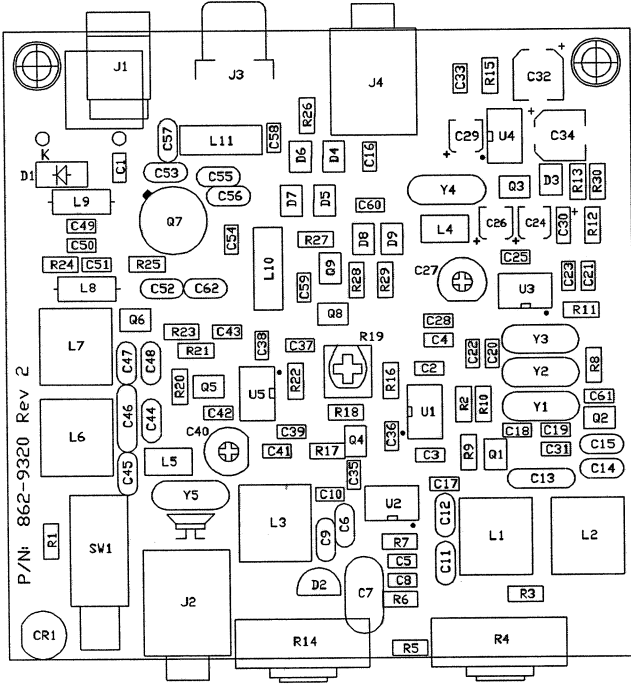

SCHEMATIC

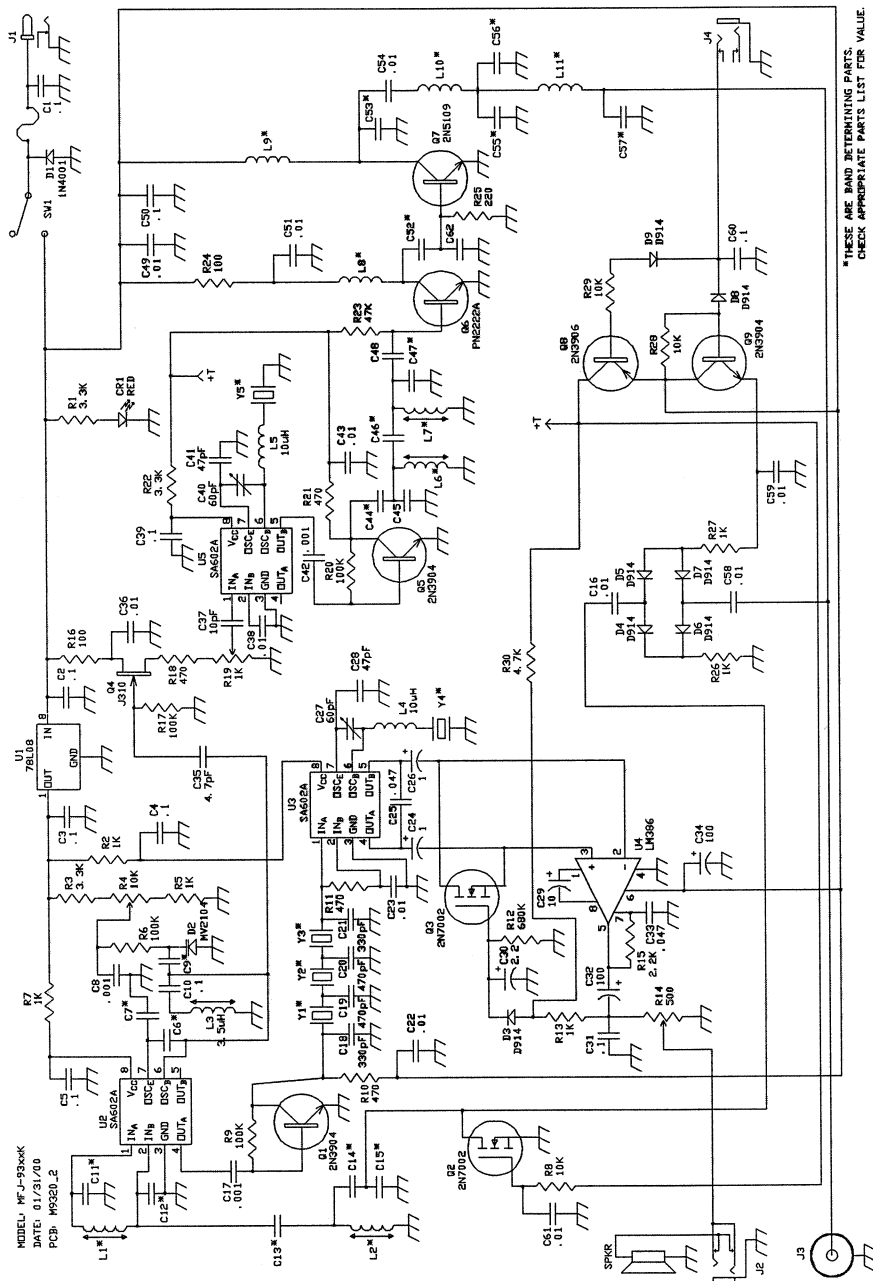

NOTES

LIMITED 12 MONTH WARRANTY

MFJ Enterprises, Inc. warrants to the original owner of this product, if manufactured by MFJ Enterprises, Inc. and purchased from an authorized dealer or directly from MFJ Enterprises, Inc. to be free from defects in material and workmanship for a period of 12 months from date of purchase provided the following terms of this warranty are satisfied:

1. The purchaser must retain the dated proof-of-purchase (bill of sale, canceled check, credit card or money order receipt, etc.) describing the product to establish the validity of the warranty claim and submit the original or machine reproduction of such proof of purchase to MFJ Enterprises, Inc. at the time of warranty service. MFJ Enterprises, Inc. shall have the discretion to deny warranty without dated proof-of-purchase. Any evidence of alteration, erasure, or forgery shall be cause to void any and all warranty terms immediately.
2. MFJ Enterprises, Inc. agrees to repair or replace at MFJ's option without charge to the original owner any defective product under warrantee provided the product is returned postage prepaid to MFJ Enterprises, Inc. with a personal check, cashiers check, or money order for \$7.00 covering postage and handling.
3. This warranty is NOT void for owners who attempt to repair defective units. Technical consultation is available by calling Service Department at 662-323-0549 or the MFJ Factory at 662-323-5869.
4. This warranty does not apply to kits sold by or manufactured by MFJ Enterprises, Inc.
5. Wired and tested PC board products are covered by this warranty provided only the wired and tested PC board product is returned. Wired and tested PC boards installed in the owner's cabinet or connected to switches, jacks, or cables, etc. sent to MFJ Enterprises, Inc. will be returned at the owner's expense unrepared.
6. Under no circumstances is MFJ Enterprises, Inc. liable for consequential damages to person or property by the use of any MFJ products.
7. Out-of-Warranty Service: MFJ Enterprises, Inc. will repair any out-of-warranty product provided the unit is shipped prepaid. All repaired units will be shipped COD to the owner. Repair charges will be added to the COD fee unless other arrangements are made.
8. This warranty is given in lieu of any other warranty expressed or implied.
9. MFJ Enterprises, Inc. reserves the right to make changes or improvements in design or manufacture without incurring any obligation to install such changes upon any of the products previously manufactured.
10. All MFJ products to be serviced in-warranty or out-of-warranty should be addressed to:

MFJ Enterprises, Inc.
300 Industrial Park Road
Starkville, Mississippi 39759 USA

and must be accompanied by a letter describing the problem in detail along with a copy of your dated proof-of-purchase.

11. This warranty gives you specific rights, and you may also have other rights which vary from state to state.



MFJ ENTERPRISES, INC.

300 Industrial Park Road
Starkville, MS 39759

MFJ-93xxK
Operation Manual
Version 2A
Printed In U.S.A.